

MFL F Luftfilterbox

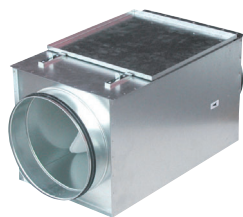

- Leergehäuse aus Stahlblech, verzinkt
- Anschluss-Stutzen mit Gummilippen-dichtungen
- Aufklappbarer Gehäusedeckel zum Filterwechsel
- Montage in beliebiger Einbaulage

Modell	Artikel Nr.	B	H	D	L	J	Gewicht [kg]	Taschenfilter-Kassette
MFL-100 F	8070404197	220	213	99	450	42	3,4	MFR-100-160 F5 od. F7
MFL-125 F	8070404198	220	213	124	450	42	3,3	MFR-100-160 F5 od. F7
MFL-150 F	8070404220	220	213	149	450	42	3,2	MFR-100-160 F5 od. F7
MFL-160 F	8070404199	220	213	159	450	42	3,2	MFR-100-160 F5 od. F7
MFL-200 F	8070404200	265	258	199	450	42	4,0	MFR-200 F5 od. F7
MFL-250 F	8070404201	315	308	249	500	60	5,5	MFR-250 F5 od. F7
MFL-315 F	8070404202	365	358	314	550	60	6,6	MFR-315 F5 od. F7
MFL-355 F	8070404203	465	458	354	650	60	8,1	MFR-355 F5 od. F7
MFL-400 F	8070404204	465	458	399	650	60	8,1	MFR-400 F5 od. F7
MFL-450 F	8070404224	565	558	449	700	81	14,5	MFR-450 F5 od. F7

- Taschenfilter-Kassette MFR M5 / F7 erforderlich

Zubehör

- Differenzdruckschalter DS-500
- Kontrollleuchte FUA

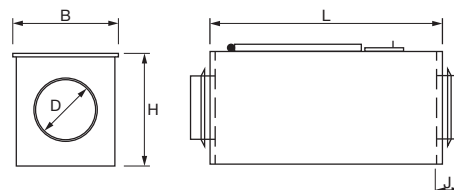

MFR Taschenfilter Kassetten M5 und F7



- Taschenfilter der Klasse M5
 - Mittlerer Abscheidegrad > 40%
 - Feuchtigkeitsbeständigkeit 100 % rel. Luftfeuchte
 - Temperaturbeständig bis 80°C
 - Empfohlene Enddruckdifferenz 250 Pa (max. 450 Pa)
- Taschenfilter der Klasse F7
 - Mittlerer Abscheidegrad > 80%
 - Feuchtigkeitsbeständigkeit 100 % rel. Luftfeuchte
 - Temperaturbeständig bis 80°C
 - Empfohlene Enddruckdifferenz 250 Pa (max. 450 Pa)

Modell	Artikel Nr.
MFR-100/125/160 M5	8070404205
MFR-200 M5	8070404208
MFR-250 M5	8070404209
MFR-315 M5	8070404210
MFR-355/400 M5	8070404211
MFR-450/500 M5	8000103968

Modell	Artikel Nr.
MFR-100/125/160 F7	8070404213
MFR-200 F7	8070404216
MFR-250 F7	8070404217
MFR-315 F7	8070404218
MFR-355/400 F7	8070404219
MFR-450/500 F7	8000103969

Druckverlust

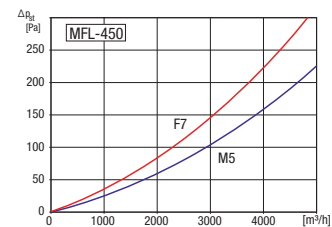
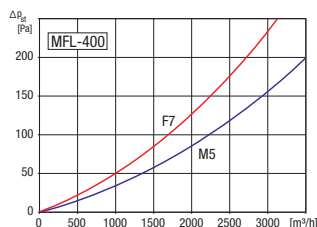
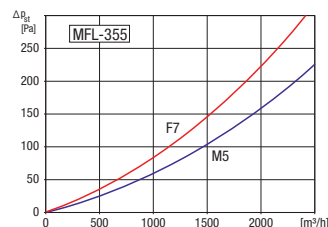
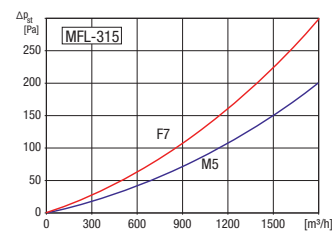
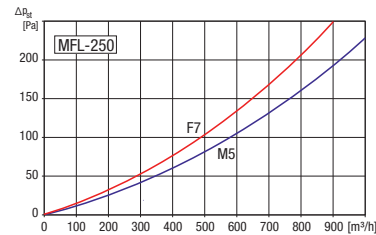
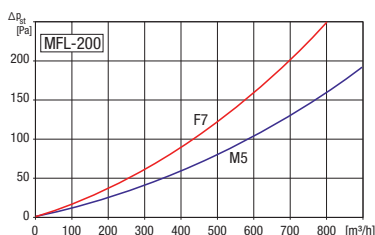
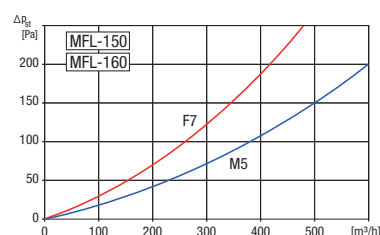
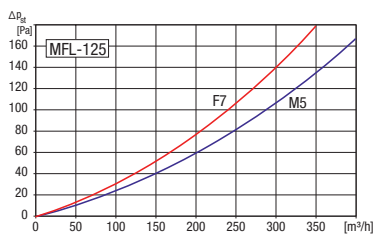
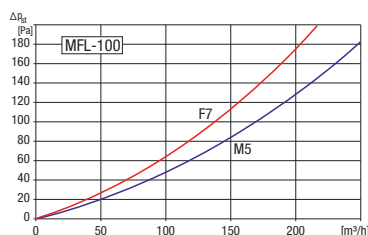

IFL F Luftfilterbox



- Leergehäuse aus Stahlblech, verzinkt
- 20 mm Normflansch
- Aufklappbarer Gehäusedeckel zum Filterwechsel
- Montage in beliebiger Einbaulage

Modell	Artikel Nr.	B	H	B1	H1	B2	H2	L	Gewicht [kg]	Taschenfilter-Kassette
IFL-200 F	8070402331	400	200	420	220	440	240	580	7,8	IFR-200 F5 od. F7
IFL-225-F	8070402332	500	250	520	270	540	290	580	9,2	IFR-225 F5 od. F7
IFL-250-F	8070402333	500	300	520	320	540	340	580	10,0	IFR-250 F5 od. F7
IFL-285-F	8070402334	600	300	620	320	640	340	580	11,4	IFR-285 F5 od. F7
IFL-315-F	8070402335	600	350	620	370	640	390	580	12,0	IFR-315 F5 od. F7
IFL-355-F	8070402336	700	400	720	420	740	440	580	11,8	IFR-355 F5 od. F7
IFL-400-F	8070402337	800	500	820	520	840	540	580	16,8	IFR-400 F5 od. F7
IFL-450-F	8070402338	1000	500	1020	520	1040	540	580	18,8	IFR-450 F5 od. F7

- Taschenfilter-Kassette IFR M5 / F7 erforderlich

Zubehör

- Differenzdruckschalter DS-500
- Kontrollleuchte FUA

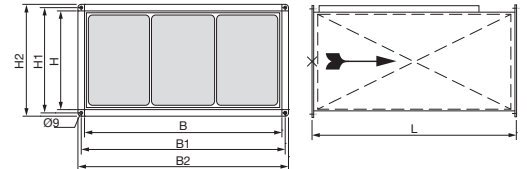

IFR Taschenfilter Kassetten M5 und F7

- Taschenfilter der Klasse M5
- Mittlerer Abscheidegrad > 40%
- Feuchtigkeitsbeständigkeit 100 % rel. Luftfeuchte
- Temperaturbeständig bis 80°C
- Empfohlene Enddruckdifferenz 250 Pa (max. 450 Pa)
- Taschenfilter der Klasse F7
- Mittlerer Abscheidegrad > 80%
- Feuchtigkeitsbeständigkeit 100 % rel. Luftfeuchte
- Temperaturbeständig bis 80°C
- Empfohlene Enddruckdifferenz 250 Pa (max. 450 Pa)

Modell	Artikel Nr.
IFR-200 M5	8000103936
IFR-225 M5	8000103937
IFR-250 M5	8000103938
IFR-285 M5	8000103939
IFR-315 M5	8000103940
IFR-355 M5	8000103941
IFR-400 M5	8000103942
IFR-450 M5	8000103943

Modell	Artikel Nr.
IFR-200 F7	8000103944
IFR-225 F7	8000103945
IFR-250 F7	8000103946
IFR-285 F7	8000103947
IFR-315 F7	8000103948
IFR-355 F7	8000103949
IFR-400 F7	8000103950
IFR-450 F7	8000103951

Druckverlust

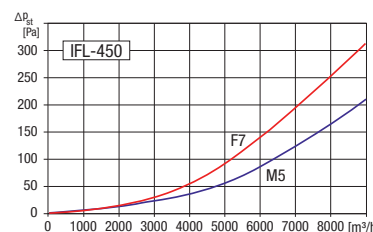
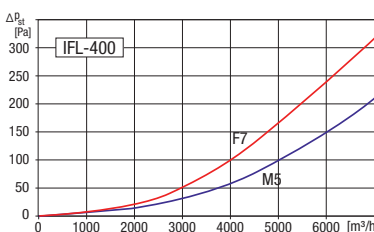
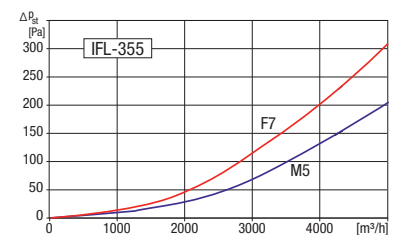
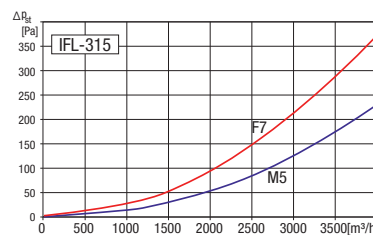
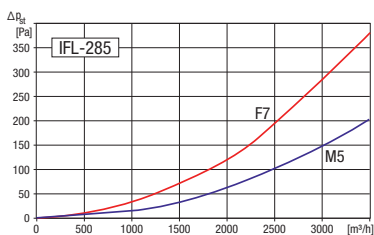
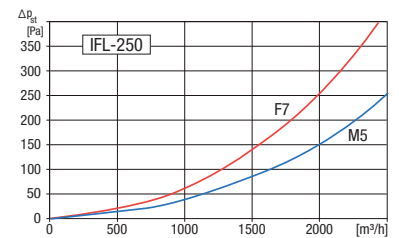
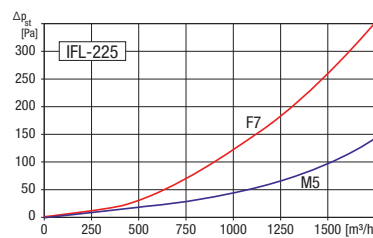
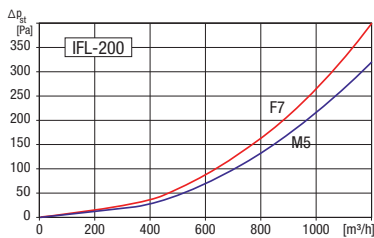

MFL Luftfilterbox G4

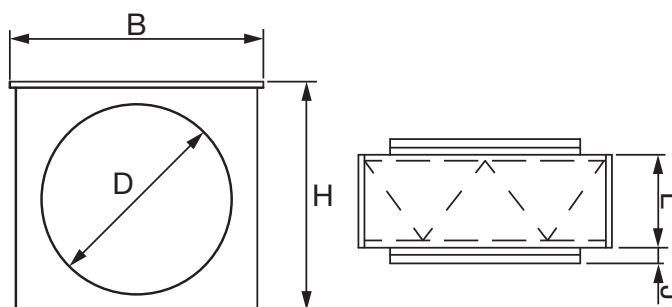

- Gehäuse aus verzinktem Stahlblech
- Vliesfiltermatte der Klasse G4
- Anschluss-Stutzen mit Gummilippen-dichtungen
- Leicht abnehmbarer Deckel zum Filterwechsel
- Abscheidegrad > 90%
- Temperaturbeständig bis 80°C
- Empfohlene Enddruckdifferenz 150 Pa
- Montage in beliebiger Einbaulage

Modell	Artikel Nr.	B	H	D	L	J	Gewicht [kg]	Ersatzfilter	Artikel Nr.
MFL-100	8000103805	200	200	99	154	42	3,4	MFR-100-160 G4	8070402173
MFL-125	8000103806	200	200	124	154	42	3,3	MFR-100-160 G4	8070402173
MFL-150	8070402345	200	200	149	154	42	3,2	MFR-100-160 G4	8070402173
MFL-160	8000103807	200	200	159	154	42	3,2	MFR-100-160 G4	8070402173
MFL-200	8000103808	244	243	199	154	42	4,0	MFR-200 G4	8070402175
MFL-250	8000103809	294	293	249	154	60	5,5	MFR-250 G4	8070402176
MFL-315	8000103810	343	342	314	154	60	6,6	MFR-315 G4	8070402178
MFL-355	8000104947	448	447	354	154	60	8,1	MFR-355/400 G4	8070404179
MFL-400	8000104948	448	447	399	154	60	8,1	MFR-355/400 G4	8070404179

Widerstandskennlinie für G4 Filter

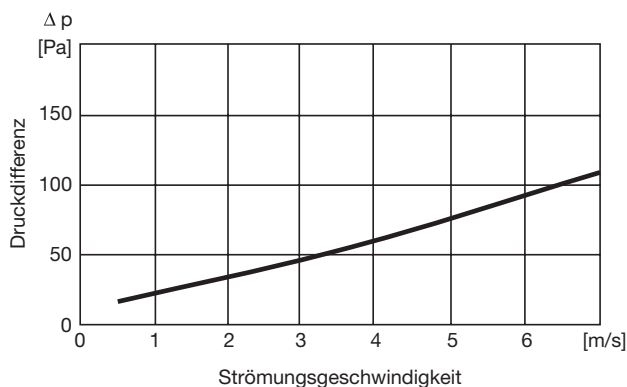

IFL Luftfilterbox G4

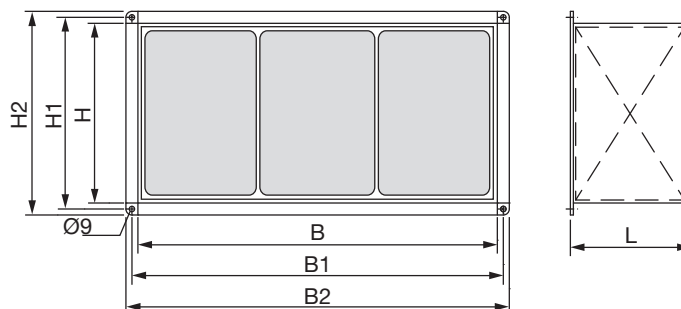

- Gehäuse aus verzinktem Stahlblech
- Vliesfiltermatte der Klasse G4
- 20 mm Normflansch
- Leicht aufklappbarer Deckel zum Filterwechsel
- Abscheidegrad > 90%
- Temperaturbeständig bis 80°C
- Empfohlene Enddruckdifferenz 150 Pa
- Montage in beliebiger Einbaulage

Modell	Artikel Nr.	B	H	B1	H1	B2	H2	L	Gewicht [kg]	Ersatzfilter	Artikel Nr.
IFL-200 G4	8070402360	400	200	420	220	440	240	190	3,5	IFR-200 G4	8070402371
IFL-225 G4	8070402361	500	250	520	270	540	290	190	4,0	IFR-225 G4	8070402372
IFL-250 G4	8070402362	500	300	520	320	540	340	190	4,5	IFR-250 G4	8070402373
IFL-285 G4	8070402363	600	300	620	320	640	340	190	5,0	IFR-285 G4	8070402374
IFL-314 G4	8070402364	600	350	620	370	640	390	190	5,5	IFR-315 G4	8070402375
IFL-355 G4	8070402365	700	400	720	420	740	440	190	6,0	IFR-355 G4	8070402376
IFL-400 G4	8070402366	800	500	820	520	840	540	190	7,5	IFR-400 G4	8070402377
IFL-450 G4	8070402367	1000	500	1020	520	1040	540	190	9,0	IFR-450 G4	8070402378